

**NEW**

## Hydraulic Excavator JS220 SC/LC/NLC



Engine Power: 128kW (172hp) Bucket Capacity: 0.40 – 1.19m<sup>3</sup> Operating Weight: 21144 – 22490kg

A Product of Hard Work



# Redefining excavation

## Contents

**Strength inside and out** pages 4 – 7

**Maximum productivity, minimum spend** pages 8 – 11

**A comfortable favourite** pages 12 – 15

**Less servicing, more service** pages 16 – 19

**The safe choice** pages 20 – 22

**LiveLink, knowledge is power** page 23

**Value added** page 24

**Specification** pages 25 – 31





**Strength**  
**inside and out**



## Boom and dipper

Reinforced boom  
Endurance testing  
Precision engineering

## Structural strength

High-strength undercarriage  
Rigid upper frame  
Stiff, durable door design

## Componentry

Best components in the industry

BEFORE YOU BUY AN EXCAVATOR, YOU NEED TO KNOW IT'S GOING TO BE TOUGH ENOUGH TO PERFORM ANY JOB YOU ASK OF IT. FORTUNATELY, WITH A JCB JS220, STRENGTH AND DURABILITY COME AS STANDARD.



1

### Boom and dipper

1 A JCB JS220's reinforced boom and dipper is made of high tensile strength steel, with single piece wrapper plates and internal baffle plates for long life durability.

2 Our advanced manufacturing and assembly processes produce high precision and quality assembled components.

### Componentry

3 JCB JS220s boast the best components in the industry, including Berco running gear, Kawasaki pumps, Isuzu engine and Kayaba main control valves.



2

We use Finite Element Analysis with extensive rig and endurance testing to make key components last longer.



3



3



### Structural strength

- 4 The high-strength undercarriage of a JCB JS220 uses a fully-welded X frame construction for long-term durability even in the most demanding applications.
- 5 A closed box section revolving frame increases strength and reduces stress. It is also highly resistant to impact damage.
- 6 The JS220's high-strength rigid upper frame provides maximum durability and support.
- 7 Our stiff, durable door design gives great strength and rigidity.

**UNEARTHED: KEY FACT**  
 The JCB JS220 turret is welded to both the upper and lower undercarriage frame.

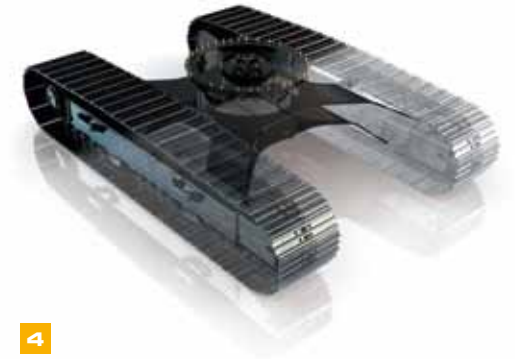

4



5



7



6

**maximum**  
**productivity,**  
**minimum spend**



## Upping output

- 12% more productive over rivals
- Intuitive multifunction operation
- Four operating work modes

## Efficiency

- Eco mode gives 11% fuel savings
- Optimised hydraulic settings

## Stability, hydraulics and attachments

- Hydraulic regeneration system
- Cushioned boom and dipper ends

# IT'S MORE IMPORTANT THAN EVER TO SAVE MONEY AND TIME; THE JCB JS220 RANGE IS DESIGNED TO MAKE THE MOST OF BOTH.



3

## Upping output

1 With a massive 155kn bucket tearout, a JCB JS220 is up to 12% more productive than its closest competitors.

2 Simultaneous tracking and excavating is smooth and fast with an intuitive multifunction operation.

## Efficiency

Advanced hydraulic technology ensures that the machines always starts in ECO mode for maximum fuel efficiency, contributing to fuel savings of up to 11%.

Optimised hydraulic pump settings and a revised spool configuration within the main valve block, only delivers the required oil flow, preventing wasted energy.

3 Tier 3 compliant Isuzu engine benefits from a revised electronic control system, delivering high torque at low revs and the highest power rated engine of 128kW (172hp) in the 20T market.



2



3

### Four operating work modes allow a JCB JS220 operator to tailor performance:

**AUTO:** For heavy digging and high-output applications. Automatically adjusts engine speed and hydraulic flow depending on load.

**ECONOMY:** Gives you maximum fuel efficiency.

**PRECISION:** Reduces hydraulic flow and engine rpm, giving control and accuracy for fine work and grading.

**LIFTING:** Gives maximum power with reduced oil flow for controllability.

**UNEARTHED: KEY FACT**

To save fuel, JCB Auto-Idle technology automatically reduces engine speed when hydraulics aren't in use.



**Stability, hydraulics and attachments**

4 JCB's innovative hydraulic regeneration system means oil is recycled across the cylinders for faster cycle times and reduced fuel consumption.

5 A JCB JS220 has cushioned boom and dipper ends to prevent shock loadings, protect your machine and increase operator comfort.

6 A JCB JS220 has a solid, stable work platform for fast cycle times.

7 JCB's quickhitch system makes attachment changing fast and easy, and is purpose-designed for the JS range.

For ultra versatility, JCB offers a full list of auxiliary pipework options including hammer, auxiliary, merged and low flow.



4



6



7

**a comfortable**  
**favourite**

## Comfortably in control

Intuitive controls

Choose from short or long stroke

Balanced slew

## Visibly better

70/30 front screen split

Laminated glass roof



## Even more benefits

Adjustable cab and controls

Minimal noise and vibration

WE'VE DESIGNED THE JCB JS220 TO BE COMFORTABLE, ERGONOMIC, SIMPLE AND INTUITIVE TO OPERATE. WHICH IS GOOD FOR YOUR OPERATORS BUT EVEN BETTER FOR YOU; AFTER ALL, GREAT EASE OF USE EQUALS GREAT PRODUCTIVITY.

### Visibly better

- 1 JCB JS220s have excellent front visibility with a 70/30 front screen split and a clear view of the front right track for easy, safe trench digging and manoeuvring.
- 2 A large laminated glass roof window gives the JS220 optimum visibility for working at height.

### Comfortably in control

- 3 Light, intuitive and smooth controls improve comfort and productivity.  
Choose between short stroke or long stroke hand control levers for operator choice and comfort.
- 4 JCB JS220s have proportional auxiliary control options for smooth, precise control.
- 5 For even greater speed and control, a JCB JS220 has a balanced slew and electronic/hydraulic controlled slew braking.

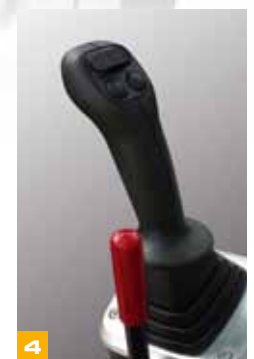



### Even more comfort

**6** JCB JS220s have a spacious luggage tray behind the operator's seat.

**7** Function switches are easy to reach and include the heater and climate control panels, while the side unit doubles as part of the immobiliser code selector.

**8** The easily-accessible Advanced Monitoring System can keep tab on a JCB JS220's functions and inputs while different working modes are selected either manually or automatically.

**9** JCB JS220 cabs use 6 viscous rubber mounts to minimise noise and vibration.

**10** A large floor area with large high grip pedals give easy and precise tracking.

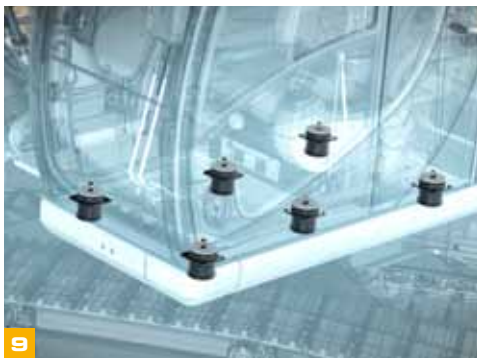

The JS220's cab and controls are independently adjustable so that it's easy to find the perfect operating position.



JCB's climate control option offers a precisely controlled cab temperature with fresh or recirculated air. Demisting/defrosting functions keep a JS220's front window clear.

**less servicing,  
more.  
service**



### Easy does it

1000-hour boom and dipper greasing intervals

5000-hour oil life

Easily-accessible filters

### Here to help

In-cab system monitoring

The best back-up in the business

Centralised grease points

Large service bays

Radiator, cooler and intercooler easily accessed

WE'VE DESIGNED JCB JS220S TO BE LOW MAINTENANCE AND EASILY SERVICEABLE. WHICH MAKES THEM AFFORDABLE, EFFICIENT AND HIGHLY PRODUCTIVE. HELPING YOU GET THE BEST SERVICE FROM YOUR MACHINE.



**Easy does it**

- 1** The air filter on a JS220 is easily accessible, and a double-element construction simplifies cleaning.
- 2** JCB's Plexus Oil Filter System extends oil life to 5000hrs by constantly filtering hydraulic fluid down to 2 microns, reducing risk of contamination.
- 3** The filters on a JCB JS220 (engine oil, hydraulic oil and fuel) are centrally located for fast, easy servicing.

	SERVICE INTERVALS
Engine oil and oil filter	Every <b>500</b> hours
Hydraulic oil	Every <b>5000</b> hours
Hydraulic oil filter	Every <b>1 000</b> hours



(A) Hydraulics oil filters (B) Fuel filters (C) JCB Plexus Oil Filter System



**UNEARTHED: KEY FACT**  
JCB JS220 grease points are centralised for safe and easy access to high level pivots.

JCB JS220 bonnets open and close easily with gas-assisted cylinders, and the service bays are large and wide for good access.



4

**Here to help**

4 JCB's In-Cab Monitor checks engine oil levels and system errors on start-up.

5 Because they're mounted side by side on a JCB JS220, the engine radiator, hydraulic cooler and intercooler can be serviced individually yet cleaned easily.

6 Service your JCB JS220 with your local main dealer and our trained engineers can minimise downtime. Order genuine JCB parts online and, in 95% of cases, they'll be with you next day. For extra security and machine protection, opt for a package like JCB LiveLink remote machine monitoring.



5



6



6

**the safe choice**



### Safety first

- Front-to-rear bonnet opening
- ROPS/FOPS protection
- Easily-isolated hydraulics
- Great visibility
- Anti-slip steps and platform
- Optional rear-view camera
- Optional full mirror set
- Engine/hydraulic heat shield

## ON-SITE SAFETY IS CRUCIAL, SO WE'VE DESIGNED THE JS220 TO INCORPORATE AS MANY CUTTING EDGE SAFEGUARDS AS POSSIBLE. IN SHORT, YOUR OPERATORS ARE IN SAFE HANDS.

We've fitted as standard a bulk head heat shield between the pumps and the engine to guard against heat and noise.



1

**1** JCB JS220 bonnet opens front-to-rear for easy and safe engine service access.

**2** For extra peace of mind, JCB JS220 cabs are available with an integral rollover protection structure (ROPS). It's easy to fit JCB's FOPS (Falling Objects Protection Structure) to a JS220 cab, thanks to standard fitment mounting brackets.

**3** JCB's Safety Lever Lock fully isolates hydraulic functions to avoid unintended movements. Our start function means a JCB JS220 can only be started in a safe locked position.

**4** JCB JS220s have a large glass area and low bonnet line for superb visibility.

**5** A JCB JS220's steps and platforms have anti-slip punched steel plates for optimum grip, even in wet or icy conditions. Bolt-on plates have recessed bolts to reduce trip hazard.

**6** JCB's optional rear-view camera displays an uninterrupted backwards view on an in-cab colour monitor.

**7** Equip your JCB JS220 with a full set of side and rear view mirrors for all round visibility and safety compliance.



2



3



7



6



5



5



7



6

# LIVELINK, KNOWLEDGE IS POWER

**JCB LIVELINK IS AN INNOVATIVE SOFTWARE SYSTEM THAT LETS YOU MONITOR AND MANAGE YOUR MACHINES REMOTELY – ONLINE, BY EMAIL OR BY MOBILE PHONE. LIVELINK GIVES YOU ACCESS TO A WHOLE HOST OF USEFUL DATA, INCLUDING MACHINE ALERTS, FUEL REPORTS\* AND EVENT HISTORY INFORMATION. ALL YOUR MACHINE INFORMATION IS HANDLED AT A SECURE DATA CENTRE FOR YOUR PEACE OF MIND.**



### Productivity and cost benefits

For ultimate productivity and cost-saving, JCB LiveLink provides information like idle time monitoring\* and machine fuel consumption\* to help reduce your fuel usage. Machine location information can improve fleet efficiency and you may even enjoy reduced insurance costs courtesy of the added security that LiveLink brings.

\* These features require an electronic engine.

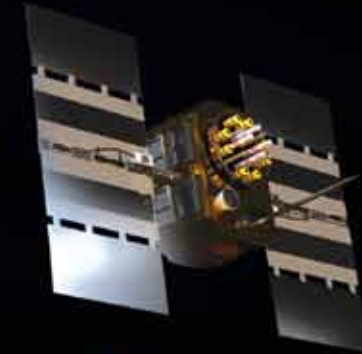
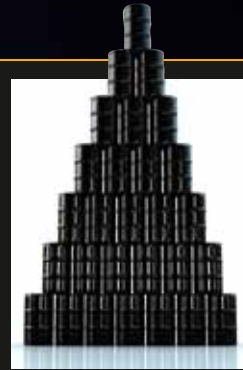

### Maintenance benefits

JCB LiveLink makes it easy to manage machine maintenance. Accurate hours monitoring and service alerts improve maintenance planning, and real-time location data helps you manage your fleet. You'll also have access to critical machine alerts and maintenance history records.



### Security benefits

Keep your machine operating safely with JCB LiveLink. Real-time geofencing alerts tell you when machines move out of predetermined operating zones, and real-time curfew alerts inform you if machines are being used when they're not supposed to be. Real time location information helps you store your machines in the safest places.



## VALUE ADDED

JCB'S WORLDWIDE CUSTOMER SUPPORT IS FIRST CLASS. WHATEVER YOU NEED AND WHEREVER YOU ARE, WE'LL BE AVAILABLE QUICKLY AND EFFICIENTLY TO HELP MAKE SURE YOUR MACHINERY IS PERFORMING TO ITS FULL POTENTIAL.



**1** Our Technical Support Service provides instant access to factory expertise, day or night, while our Finance and Insurance teams are always on hand to provide fast, flexible, competitive quotes.

**2** JCB Assetcare offers comprehensive extended warranties and service agreements, as well as service-only or repair and maintenance contracts. Irrespective of what you opt for, our Maintenance teams around the world charge competitive labour rates, and offer non-obligation quotations as well as fast, efficient insurance repair work.



**3** The global network of JCB Parts Centres is another model of efficiency; with 16 regional bases, we can deliver around 95% of all parts anywhere in the world within 24 hours. Our genuine JCB parts are designed to work in perfect harmony with your machine for optimum performance and productivity.

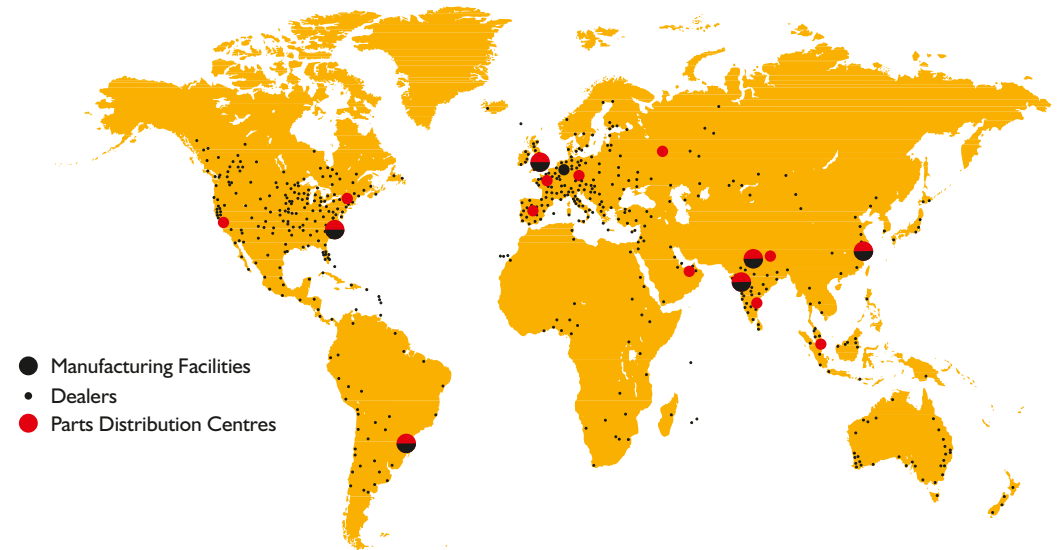
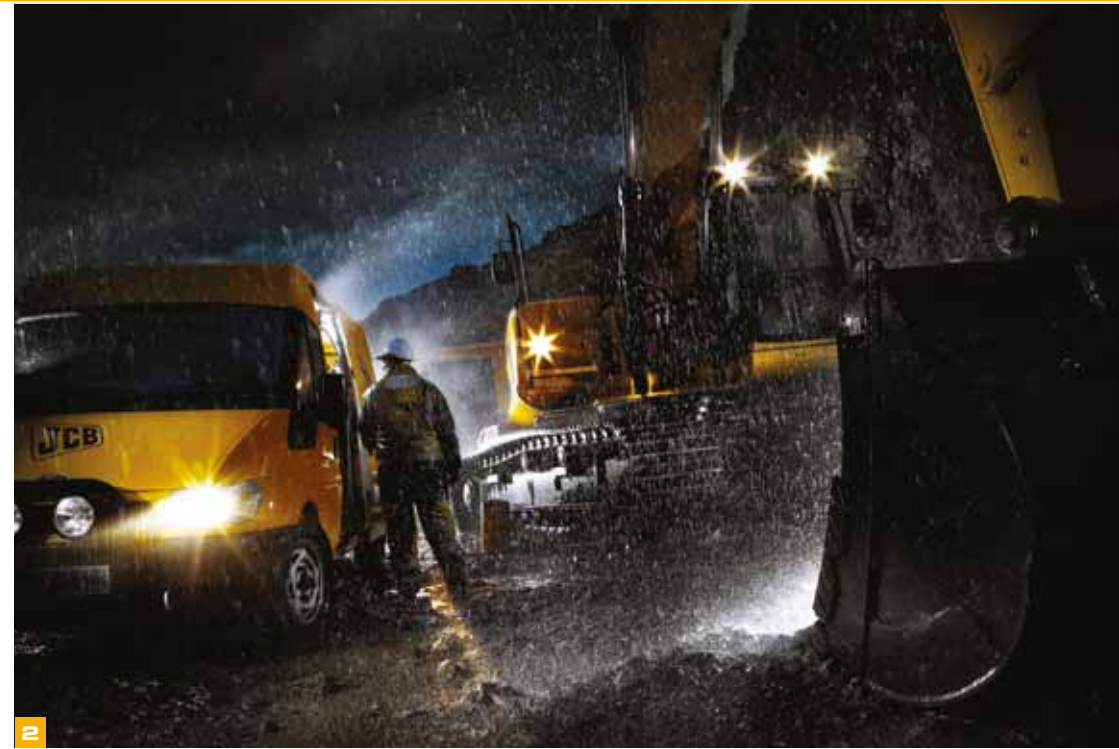

## ENGINE

<b>Model</b>	Isuzu 4HKIX. European Tier III emissions compliant.
<b>Type</b>	Water cooled, 4-stroke, 4-cylinder in-line, direct injection, turbocharged diesel.
<b>Nett power (ISO 3046-1NF)</b>	128kW (172hp) at 2000rpm.
<b>Piston Displacement</b>	5.193 litres.
<b>Injection</b>	Electronic injection.
<b>Air Filtration</b>	Dry element with secondary safety element and in cab warning indicator.
<b>Cooling</b>	Water cooler via large capacity radiator.
<b>Starter motor</b>	24 volt – 4.5kW.
<b>Batteries</b>	2 x 12 volt Heavy-duty.
<b>Alternator</b>	24 volt 40 amp.
<b>Refuelling pump</b>	Electric type.

## SWING SYSTEM

<b>Swing motor</b>	Axial piston.
<b>Swing brake</b>	Hydraulic braking plus automatic spring applied disc type parking brake.
<b>Final drive</b>	Planetary reduction.
<b>Swing speed</b>	12.9rpm.
<b>Swing gear</b>	Large diameter, internally toothed fully sealed grease bath lubricated.
<b>Swing lock</b>	Switchable brake in cab.

## UNDERCARRIAGE

<b>Carriage options</b>	SC-Standard, NC-Narrow and LC-Long Carriage.	
<b>Construction</b>	Fully welded, "X" frame type with central bellyguarding and track motor guards. Sloping sidemembers with dirt relief holes under top rollers. Front and rear.	
<b>Recovery point</b>	Sealed and greased.	
<b>Track type</b>	NC & SC – 500mm (20in), 600mm (24in), 700mm (28in). LC – 600mm (24in), 700mm (28in), 800mm (31.5in), 900mm (36in).	
<b>Track shoe options</b>	Heat treated, sealed and lubricated.	
<b>Upper &amp; lower rollers</b>	Grease cylinder type.	
<b>Track adjustment</b>	Sealed and lubricated, with spring cushioned recoil.	
<b>Track idler</b>	<b>NC &amp; SC</b>	<b>LC</b>
<b>No. of track guides</b>	2 per side	2 per side
<b>No. of lower rollers</b>	7 per side	8 per side
<b>No. of upper rollers</b>	2 per side	2 per side
<b>No. of track shoes</b>	46 per side	49 per side

## ENVIRONMENT

<b>Noise levels</b>	LwA external: dBA 103 LwA operator ear: dBA 72
---------------------	---

## HYDRAULICS

A variable flow load sensing system with flow on demand, variable power output and servo operated, multi-function open centre control. Machine auto warm up standard – maximises performance in cold conditions.

### Pumps

<b>Main pumps</b>	2 variable displacement axial piston type.
<b>Maximum flow</b>	2 x 214 L/min (2 x 47 UK GPM).
<b>Servo pump</b>	Gear type.
<b>Maximum flow</b>	20 L/min (4.4 UK GPM).

### Control valve

A combined four and five spool control valve with auxiliary service spool as standard. When required twin pump flow is combined to boom, dipper and bucket services for greater speed and efficiency.

### Relief valve settings

<b>Boom/Arm/Bucket</b>	343 bar (4975 lbf/sq.in)
<b>Automatic power boost</b>	373 bar (5410 lbf/sq.in)
<b>Swing circuit</b>	289 bar (4190 lbf/sq.in)
<b>Travel circuit</b>	343 bar (4975 lbf/sq.in)
<b>Pilot control</b>	40 bar (580 lbf/sq.in)

A separate Cushion Control valve in the servo system provides cushioning of the boom and dipper spools selection and quick warm-up of the servo system.

### Hydraulic cylinders

Double acting type, with bolt-up end caps and hardened steel bearing bushes. End cushioning is fitted as standard on boom, dipper and bucket rams.  
Optional hose burst check valves available for boom and dipper rams.

### Filtration

The hydraulic components are protected by the highest standard of filtration to ensure long hydraulic fluid and component life.

<b>In tank</b>	150 micron, suction strainer.
<b>Main return line</b>	10 micron, fibreform element.
<b>Plexus Bypass line</b>	1.5 micron, paper element.
<b>Pilot line</b>	10 micron, paper element.
<b>Hydraulic hammer return</b>	10 micron, reinforced microform element.

### Cooling

Cooling is provided via a full return line air blast cooler as part of a single face cooling pack in conjunction with the engine water cooler.

## TRACK DRIVE

<b>Type</b>	Fully hydrostatic, three speed with autoshift between high and medium speed.
<b>Travel motors</b>	Variable swash axial piston type, fully guarded within undercarriage frame.
<b>Final drive</b>	Planetary reduction, bolt-on sprockets.
<b>Service brake</b>	Hydraulic counter balance valve to prevent overspeeding on gradients.
<b>Park brake</b>	Disc type, spring applied, automatic hydraulic release.
<b>Gradeability</b>	70% (35 deg) continuous.
<b>Travel speed</b>	High – 5.6 km/h (3.4 mph). Mid – 3.3 km/h (2.1 mph). Low – 2.3 km/h (1.4 mph).
<b>Tractive effort</b>	191.9kN (19570 kgf, 43144 lbf).

DRIVES AND BRAKES

Steering control	Twin pedal and levers giving independent track control
Drive method	Hydrostatic
Travel operation	3 speed with automatic shift between medium and high speed
Gradeability	70% 35°
<b>Maximum travel speeds</b>	Low – 2.3 km/h (1.4 mph) Medium – 3.3 km/h (2.1 mph) High – 5.6 km/h (3.4 mph)
Tractive effort	202.3 kN (20629/45479 kgf/lbf)
Brake system	Hydraulically operated discs in each travel motor

EXCAVATOR END

Monoboom available along with a choice of dipper lengths to suit the requirements of reach, dig-depth, loadover height, tearouts and site versatility. Reserve strength is built into the fully welded structures for hydraulic hammer and other arduous operations. Fabricated bucket tipping links are provided with a choice of lift points. Strong, durable construction, large cross sections and multi plate fabrications to withstand high stress applications. The 5.7m (18ft 8in) boom is designed to ensure the optimum digging envelope when matched with the three dipper lengths. Low maintenance bronze alloy bushes with graphite plugs are fitted to boom base and boom to dipper pivots resulting in 1000 hour greasing intervals at these points.

CAB

Excellent digging, loading and positioning visibility results from the careful design of front, side and roof lights. All screens are tinted to improve in cab conditions. Fully opening front screen is very smooth to operate and as the lower screen is stored in rear of cab. Fresh air ventilation available from opening door window, opening slot in front screen and fully opening front screen. Parallelogram wash wiper for upper screen ensuring good wiped area for maximum visibility. Wiper motor is fitted in the left hand side of the roof screen so as not to affect bucket visibility when loading. Optional lower screen wiper available. Fresh air ventilation and heater with windscreen demister. Infinitely variable blower speed, temperature and recirculation control. Optional climate control. Fully adjustable deluxe suspension seat with arm rest adjustment and backrest recline. Optional radio with digital tuner fitted into the roof lining for maximum protection. Conveniently placed radio mute button incorporated into lower console. 12v power point and mobile phone holder built into the right hand console. Courtesy light can be operated from ground level and is illuminated for five minutes or until switched off improving operator access at night. Cab mounted roller blind protects operator from suns' glare through front or top screens.

SERVICE CAPACITIES

Fuel tank	litres (UK gal)	343 (75.4)
Radiator	litres (UK gal)	25.5 (5.61)
Engine oil	litres (UK gal)	17.5 (3.85)
Swing drive	litres (UK gal)	5.0 (1.1)
Hydraulic tank	litres (UK gal)	120 (26.4)
Final drive (each side)	litres (UK gal)	4.7 (1.0)

AMS – ADVANCED MANAGEMENT SYSTEM

Four selectable working modes link the operators control movements with the engine and hydraulic systems to maximise productivity and efficiency.

- A (Auto)** Up to 100% engine power and 100% flow. Gives variable power and speed depending on the operator's input, matching the demand for output and efficiency to the job. Power boost is automatically activated in this mode should hard conditions be encountered. Auto idle cuts in after a period of inactivity (between 5 and 30 seconds as set by the operator)
- E (Economy)** 80% engine power. 95% of hydraulic flow maximises economy while maintaining excellent output.
- P (Precision)** 55% engine power. 90% of hydraulic flow for fine control of grading operations.
- L (Lifting)** 55% engine power. 63% of hydraulic flow with permanent power boost for maximum lifting power and control.

The Auto mode allows the AMS processor to select the optimum operational performance to match the demands of the job while the three alternative modes give precise matching of application when specific tasks are undertaken.

The adjustable position monitor mounted on the front right hand pillar of the cab gives the operator a constant read out of mode, tracking range, operating temperature and a host of other information, while retaining excellent visibility of the monitor and the job being carried out.

The required flow for hammer applications can be set and stored in the AMS memory and is automatically activated whenever the hammer pedal is depressed.

A maintenance indicator warns of imminent service needs, and all servicing and basic checks can be carried out using only the in cab display.

CONTROLS

- Excavator** All servo lever operated to ISO control pattern, independently adjustable to the seat.
- Tracks** Individually servo operated by foot pedal or hand lever.  
Speed selection via joystick button.
- Auxiliary** Via servo operated foot pedal.
- Control isolation** Via gate lock lever at cab entrance or panel switch.
- Engine speed** Dial type throttle control plus servo lever mounted one-touch idle control or separate selectable auto-idle with adjustable time delay using AMS.
- Engine stop** Ignition key operated and separate shut-down button.
- Horn** Operated via servo lever mounted button.

STATIC DIMENSIONS – JS220 NLC/SC/LC MONOBOOM

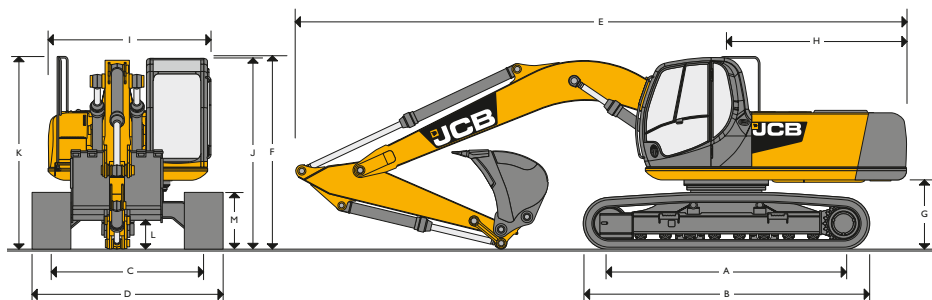

Dimensions in millimetres (ft-in)	NLC	SC	LC
A Track length on ground	3660 (12-0)	3370 (11-1)	3660 (12-0)
B Undercarriage overall length	4460 (14-6)	4170 (13-8)	4460 (14-8)
C Track gauge	1990 (6-6)	2200 (7-2)	2390 (7-10)
D Width over tracks (500mm trackshoes)	2490 (8-2)	2700 (8-10)	-
D Width over tracks (600mm trackshoes)	2590 (8-6)	2800 (9-2)	2990 (9-10)
D Width over tracks (700mm trackshoes)	2690 (8-10)	2900 (9-6)	3090 (10-2)
D Width over tracks (800mm trackshoes)	-	-	3190 (10-6)
D Width over tracks (900mm trackshoes)	-	-	3290 (10-10)
<b>Dipper lengths</b>	<b>1.91 m (6ft 3in)</b>	<b>2.40m (7ft 10in)</b>	<b>3.0m (9ft 10in)</b>
E Transport length with Monoboom	9570 (31-5)	9560 (31-4)	9440 (31-0)
F Transport height with Monoboom	3055 (10-0)	3060 (10-0)	3025 (9-11)
G Counterweight clearance		1066 (3-6)	
H Tailswing radius		2825 (9-3)	
I Width of superstructure		2549 (8-4)	
J Height over cab		2946 (9-8)	
K Height over grab rail		3025 (9-11)	
L Ground clearance		486 (1-7)	
M Track height		885 (2-11)	

WEIGHTS AND GROUND BEARING PRESSURES

Figures include 1.14cu.m. bucket 760kg (1675lbs), operator, full fuel tank, 600mm track shoes and 2.4m dipper.

MONOBOOM		500mm shoes	600mm shoes	700mm shoes	800mm shoes	900mm shoes
<b>JS220NLC</b>						
Machine weight	kg (lb)	21144 (46615)	21396 (47170)	21648 (47725)	-	-
Ground bearing pressure	kg/cm (lb/ft <sup>2</sup> )	0.51 (7.25)	0.43 (6.11)	0.37 (5.26)	-	-
<b>JS220SC</b>						
Machine weight	kg (lb)	21227 (46800)	21479 (47350)	21731 (47900)	-	-
Ground bearing pressure	kg/cm (lb/ft <sup>2</sup> )	0.51 (7.25)	0.43 (6.11)	0.37 (5.26)	-	-
<b>JS220LC</b>						
Machine weight	kg (lb)	-	21904 (48290)	22172 (48880)	22440 (49470)	22490 (49580)
Ground bearing pressure	kg/cm (lb/ft <sup>2</sup> )	-	0.41 (5.83)	0.36 (5.12)	0.31 (4.41)	0.28 (3.98)

BUCKET AND ARM FORCE

Arm length		1.91m (6ft 3in)	2.40m (7ft 10in)	3.00m (9ft 10in)
Bucket digging force	kg (lb)	14550 (32080)	14550 (32080)	14550 (32080)
Bucket digging force at Power boost	kg (lb)	15800 (34835)	15800 (34835)	15800 (34835)
Arm crowd force	kg (lb)	13450 (29650)	11560 (25485)	9590 (21142)
Arm crowd force at Power boost	kg (lb)	14610 (32210)	12550 (27670)	10410 (22950)

STANDARD EXCAVATING BUCKETS

JS220 Mono Boom Bucket and Arm combination		600 (24)	900 (24)	1000 (39)	1200 (47)	1350 (53)	1450 (57)	1500 (59)
Bucket width	mm (in)							
Bucket capacity	m <sup>3</sup> (yd <sup>3</sup> )	0.40 (0.52)	0.71 (0.93)	0.81 (1.06)	1.03 (1.35)	1.05 (1.37)	1.14 (1.49)	1.19 (1.56)
Bucket weight	kg (lb)	484 (1067)	595 (1312)	627 (1382)	705 (1555)	679 (1497)	720 (1588)	734 (1618)
Undercarriage and Dipper length								
JS220NLC	1.91m (6ft 3in)	○	○	○	○	○	○	○
JS220NLC	2.40m (7ft 10in)	○	○	○	○	○	●	●
JS220NLC	3.00m (9ft 10in)	○	○	○	●	●	■	■
JS220SC	1.91m (6ft 3in)	○	○	○	○	○	○	○
JS220SC	2.40m (7ft 10in)	○	○	○	○	○	○	○
JS220SC	3.00m (9ft 10in)	○	○	○	○	○	●	●
JS220LC	1.91m (6ft 3in)	○	○	○	○	○	○	○
JS220LC	2.40m (7ft 10in)	○	○	○	○	○	○	○
JS220LC	3.00m (9ft 10in)	○	○	○	○	○	○	○

○ Material weight up to 2000kg/m<sup>3</sup> (1.50t/yd<sup>3</sup>) ● Material weight up to 1800kg/m<sup>3</sup> (1.35t/yd<sup>3</sup>) ■ Material weight up to 1500kg/m<sup>3</sup> (1.1t/yd<sup>3</sup>)  
 These recommendations are given as a guide based on typical operating conditions.  
 Please contact your distributor for the correct selection of buckets and attachments to suit the application.

WORKING RANGE – JS220 NLC/SC/LC MONOBOOM

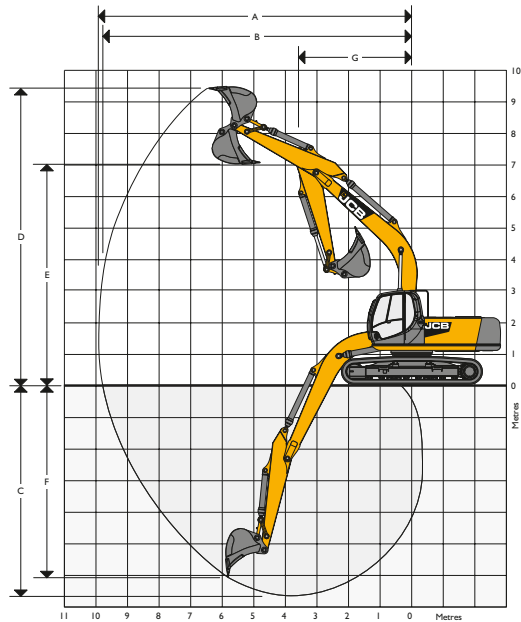

WORKING RANGE – JS220 NLC/SC/LC MONOBOOM

Boom length 5.70m (18ft 8in)					
Dipper length		1.91m (6ft 3in)	2.40m (7ft 10in)	3.00m (9ft 10in)	
A	Maximum digging reach	m (ft-in)	8.89 (29-2)	9.34 (30-8)	9.87 (32-5)
B	Maximum digging reach (on ground)	m (ft-in)	8.70 (28-7)	9.16 (30-1)	9.70 (31-10)
C	Maximum digging depth	m (ft-in)	5.53 (18-2)	6.02 (19-9)	6.60 (21-8)
D	Maximum digging height	m (ft-in)	8.95 (29-4)	9.20 (30-2)	9.40 (30-10)
E	Maximum dumping height	m (ft-in)	6.31 (20-8)	6.53 (21-5)	6.75 (22-2)
F	Maximum vertical wall cut depth	m (ft-in)	4.90 (16-1)	5.47 (17-11)	6.07 (19-11)
G	Minimum swing radius	m (ft-in)	3.76 (12-4)	3.71 (12-2)	3.60 (11-10)
	Bucket rotation	deg.	183°	183°	183°
	Dipper tearout (ISO 6015)	kgf (lbf)	13450 (29650)	11560 (25485)	9590 (21142)
	Dipper tearout with boost (ISO 6015)	kgf (lbf)	14610 (32210)	12550 (27670)	10410 (22950)
	Bucket tearout (ISO 6015)	kgf (lbf)	14550 (32080)	14550 (32080)	14550 (32080)
	Bucket tearout with boost (ISO 6015)	kgf (lbf)	15800 (34835)	15800 (34835)	15800 (34835)

STANDARD EQUIPMENT

Isuzu 4KH1X 128kW common rail, turbocharged intercooled direct injection EU Stage III and EPA Tier 3 compliant engine; Dual element type air cleaner with in-cab warning system; Automatic fuel system de-aeration; Automatic engine warm-up system; Engine overheat prevention/warning system; Automatic engine deceleration/idle function; AMS machine monitor system; 4 selectable work modes – Auto, Economy, Lifting, Precision; Remote engine oil level check; Plexus filtration system; Servo oil filtration system; Dual fuel intake filters with additional water separator; 3 speed travel system; High back suspension seat; Overload warning device; Horn; Upper and lower underguarding; Lockable service doors and engine cover; Frame mounted toolbox; Remote greasing for slew bearing; Electric refuelling pump; Handrails with non-slip walkways; Boom and mainframe mounted worklights; Toolkit; Quick connect engine oil drain; Remote mounted easy access filters; Cushion control; Operators manual.

**Auto operator cab** – Pressurised; Tinted safety glass with sun visor; Opening front window; Operator storage shelf with cargo net; Ashtray and cigarette/mobile phone charger socket; Mobile phone holder; Radio mute switch; Courtesy light; Heater and demister; Removable floor mat.

OPTIONAL EQUIPMENT











SC, LC and NLC undercarriages; 500, 600, 700, 800 and 900mm triple grouser track plates; Monoboom or T.A.B.; 1.91m, 2.4m and 3.0m dippers; Auxiliary pipework (full and lowflow), quick release couplings for auxiliary pipework, shut-off valves for auxiliary pipework; Hose burst check valves; Tipping link mounted lift points; FOPS (Level II) protection system; Mesh screen guard; Additional worklights; ISO 63 or ISO 32 hydraulic oils; Bio oil; Lower wiper; Rain visor (not available with FOPS protection or mesh screen guard); Climate control; Heated and suspension high backed seat; Radio; Fire extinguisher; Widecore radiator; Visibowl or Turbo II precleaner; P3 or carbon cab air intake filter; Travel alarm; Quickhitch pipework; JCB buckets or attachments. NB: Long Reach option available – please ask your dealer for more information.

ATTACHMENTS

<b>Surelock Hydraulic Quickhitch</b>	
<b>Hammermaster</b>	HM1570Q, HM1760Q
<b>GP Buckets</b>	Cat style teeth – 610mm, 762mm, 914mm, 1067mm, 1219mm ESCO tooth system – 550mm, 850mm, 950mm, 1150mm, 1300mm, 1400mm, 1450mm
<b>Heavy Duty Buckets</b>	ESCO tooth system – 550mm, 850mm, 1150mm, 130mm
<b>Grading Buckets</b>	1542m, 1830mm, 2058mm
<b>Selector Grab</b>	SG700 – capacity 700l
<b>Rockwheel</b>	RW100N – 1058mm (42in) cutting width
<b>Multiprocessor</b>	MP200
<b>Crusher Bucket</b>	CB70 30m³/h











LIFT CAPACITIES – Dipper length: 1.9m, Monoboom 5.7m, Trackshoes: 500mm, No bucket.

JS220 NLC MONO

Reach	3m (9ft 10in)		4.5m (14ft 9in)		6m (19ft 8in)		7.5m (24ft 7in)		Max. Reach		Max. Reach
											
Load Point Ht.	kg	kg	kg	kg	kg	kg	kg	kg	kg	kg	mm
6.0m (19.8ft)					6380*	4750			5720*	4620	6105
4.5m (14.9ft)			8020*	7030	6720*	4650			5700*	3770	6907
3.0m (9.10ft)			9870*	6550	7250	4470			5410	3380	7318
1.5m (4.11ft)			10850	6210	7060	4290			5230	3260	7406
0m			10720	6110	6950	4200			5420	3350	7182
- 1.5m (- 4.11ft)	13010*	11410	10750	6130	6940	4190			6080	3720	6614
- 3.0m (- 9.10ft)	12760*	11580	9650*	6270					7600*	4710	5596











LIFT CAPACITIES – Dipper length: 2.4m, Monoboom 5.7m, Trackshoes: 500mm, No bucket.

JS220 NLC MONO

Reach	3m (9ft 10in)		4.5m (14ft 9in)		6m (19ft 8in)		7.5m (24ft 7in)		Max. Reach		Max. Reach
											
Load Point Ht.	kg	kg	kg	kg	kg	kg	kg	kg	kg	kg	mm
7.5m (24.7ft)									5230*	5230*	5547
6.0m (19.8ft)					5810*	4840			4790*	3990	6767
4.5m (14.9ft)			7330*	7150	6290*	4710			4690	3360	7497
3.0m (9.10ft)			9230*	6680	7110*	4510	5240	3290	4800*	3060	7878
1.5m (4.11ft)			10820*	6290	7080	4320	5140	3200	4730	2950	7959
0m			10740	6120	6940	4190	5080	3150	4860	3020	7751
- 1.5m (- 4.11ft)	10850*	10850*	10710	6090	6900	4160			5340	3300	7229
- 3.0m (- 9.10ft)	14090*	11440	10270*	6180	6980	4230			6250	3980	6313
- 4.5m (- 14.9ft)			7500*	6440					6850	5960	4777

LIFT CAPACITIES – Dipper length: 3.0m, Monoboom 5.7m, Trackshoes: 500mm, No bucket.

JS220 NLC MONO



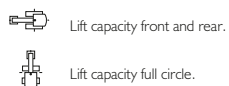







Reach	3m (9ft 10in)		4.5m (14ft 9in)		6m (19ft 8in)		7.5m (24ft 7in)		Max. Reach		Max. Reach
											
Load Point Ht.	kg	kg	kg	kg	kg	kg	kg	kg	kg	kg	mm
7.5m (24.7ft)					4350*	4350*			3440*	3440*	6285
6.0m (19.8ft)					5170*	4930			3210*	3210*	7382
4.5m (14.9ft)					5740*	4780	5190*	3410	3160*	3040	8056
3.0m (9.10ft)	11580*	11580*	8380*	6820	6630*	4560	5270	3310	3230*	2780	8411
1.5m (4.11ft)			10200*	6370	7120	4340	5150	3200	3430*	2690	8488
0m	6400*	6400*	10750	6120	6940	4180	5060	3120	3800*	2730	8293
- 1.5m (- 4.11ft)	10510*	10510*	10650	6040	6860	4110	5030	3090	4470*	2940	7807
- 3.0m (- 9.10ft)	15320*	11230	10700	6080	6880	4130			5600	3440	6969
- 4.5m (- 14.9ft)	12460*	11530	8920*	6250					6760*	4670	5619



- Notes:
1. For lifting capacity including bucket, subtract total weight of bucket or bucket and quickhitch from above values.
  2. Lifting capacities are based on ISO 10567, that is: 75% of minimum tipping load or 87% of hydraulic lift capacity, whichever is the less. Lifting capacities marked\* are based on hydraulic capacity.
  3. Lift capacities assume that the machine is on firm, level ground.
  4. Lift capacities may be limited by local regulations. Please refer to your dealer.











LIFT CAPACITIES – Dipper length: 1.9m, Monoboom 5.7m, Trackshoes: 600mm, No bucket.

JS220 SC MONO

Reach	3m (9ft 10in)		4.5m (14ft 9in)		6m (19ft 8in)		7.5m (24ft 7in)		Max. Reach		Max. Reach
											
Load Point Ht.	kg	kg	kg	kg	kg	kg	kg	kg	kg	kg	mm
6.0m (19.8ft)					6380*	5250			5720*	5100	6105
4.5m (14.9ft)			8020*	7820	6720*	5140			5700*	4170	6907
3.0m (9.10ft)			9870*	7320	7340	4950			5480	3750	7318
1.5m (4.11ft)			10990	6980	7150	4780			5300	3610	7406
0m			10860	6870	7040	4680			5490	3720	7182
- 1.5m (- 4.11ft)	13010*	13010*	10890	6890	7040	4680			6160	4140	6614
- 3.0m (- 9.10ft)	12760*	12760*	9650*	7030					7600*	5250	5596











LIFT CAPACITIES – Dipper length: 2.4m, Monoboom 5.7m, Trackshoes: 600mm, No bucket.

JS220 SC MONO

Reach	3m (9ft 10in)		4.5m (14ft 9in)		6m (19ft 8in)		7.5m (24ft 7in)		Max. Reach		Max. Reach
											
Load Point Ht.	kg	kg	kg	kg	kg	kg	kg	kg	kg	kg	mm
7.5m (24.7ft)									5230*	5230*	5547
6.0m (19.8ft)					5810*	5330			4790*	4400	6767
4.5m (14.9ft)			7330*	7330*	6290*	5200			4690*	3710	7497
3.0m (9.10ft)			9230*	7460	7110*	4990	5310	3640	4800*	3380	7878
1.5m (4.11ft)			10820*	7060	7180	4800	5210	3550	4790	3270	7959
0m			10880	6880	7040	4670	5150	3490	4930	3350	7751
- 1.5m (- 4.11ft)	10850*	10850*	10850	6860	7000	4640			5240	3670	7229
- 3.0m (- 9.10ft)	14090*	13140	10270*	6950	7080	4710			6610	4430	6313
- 4.5m (- 14.9ft)			7500*	7210					6850*	6660	4777

LIFT CAPACITIES – Dipper length: 3.0m, Monoboom 5.7m, Trackshoes: 600mm, No bucket.

JS220 SC MONO



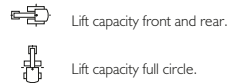







Reach	3m (9ft 10in)		4.5m (14ft 9in)		6m (19ft 8in)		7.5m (24ft 7in)		Max. Reach		Max. Reach
											
Load Point Ht.	kg	kg	kg	kg	kg	kg	kg	kg	kg	kg	mm
7.5m (24.7ft)					4350*	4350*			3440*	3440*	6285
6.0m (19.8ft)					5170*	5170*			3210*	3210*	7382
4.5m (14.9ft)					5740*	5270	5190*	3760	3160*	3160*	8056
3.0m (9.10ft)	11580*	11580*	8380*	7610	6630*	5050	5340	3670	3230*	3080	8411
1.5m (4.11ft)			10200*	7140	7210	4830	5220	3560	3430*	2990	8488
0m	6400*	6400*	10890	6880	7030	4660	5130	3470	3800*	3040	8293
- 1.5m (- 4.11ft)	10510*	10510*	10790	6800	6950	4590	5090	3440	4470*	3270	7807
- 3.0m (- 9.10ft)	15320*	12920	10770*	6840	6980	4610			5680	3820	6969
- 4.5m (- 14.9ft)	12460*	12460*	8920*	7020					6760*	5210	5619



- Notes:
1. For lifting capacity including bucket, subtract total weight of bucket or bucket and quickhitch from above values.
  2. Lifting capacities are based on ISO 10567, that is: 75% of minimum tipping load or 87% of hydraulic lift capacity, whichever is the less. Lifting capacities marked\* are based on hydraulic capacity.
  3. Lift capacities assume that the machine is on firm, level ground.
  4. Lift capacities may be limited by local regulations. Please refer to your dealer.











LIFT CAPACITIES – Dipper length: 1.9m, Monoboom 5.7m, Trackshoes: 700mm, No bucket.

JS220 LC MONO

Reach	3m (9ft 10in)		4.5m (14ft 9in)		6m (19ft 8in)		7.5m (24ft 7in)		Max. Reach		Max. Reach
											
Load Point Ht.	kg	kg	kg	kg	kg	kg	kg	kg	kg	kg	mm
6.0m (19.8ft)					6380*	5800			5720*	5640	6105
4.5m (14.9ft)			8020*	8020*	6720*	5700			5700*		
3.0m (9.10ft)			9870*	8200	7470*	5500			5980*		
1.5m (4.11ft)			11210*	7840	8160	5320			6010		
0m			11510*	7730	8050	5220			6230		
- 1.5m (- 4.11ft)	13010*	13010*	11040*	7750	8040	5220			7010		
- 3.0m (- 9.10ft)	12760*	12760*	9650*	7900					7600*		











LIFT CAPACITIES – Dipper length: 2.4m, Monoboom 5.7m, Trackshoes: 700mm, No bucket.

JS220 LC MONO

Reach	3m (9ft 10in)		4.5m (14ft 9in)		6m (19ft 8in)		7.5m (24ft 7in)		Max. Reach		Max. Reach
											
Load Point Ht.	kg	kg	kg	kg	kg	kg	kg	kg	kg	kg	mm
7.5m (24.7ft)									5230*	5230*	5547
6.0m (19.8ft)					5810*	5810*			4790*	4790*	6767
4.5m (14.9ft)			7330*	7330*	6290*	5750			4690*	4110	7497
3.0m (9.10ft)			9230*	8330	7110*	5540	6010	4040	4800*	3750	7878
1.5m (4.11ft)			10820*	7930	7930*	5340	5910	3950	5120*	3640	7959
0m			11480*	7740	8040	5220	5840	3890	5580	3730	7751
- 1.5m (- 4.11ft)	10850*	10850*	11300*	7720	8000	5180			6150	4080	7229
- 3.0m (- 9.10ft)	14090*	14090*	10270*	7810	7560*	5250			6980*	4930	6313
- 4.5m (- 14.9ft)			7500*	7500*					6850*	6850*	4777

LIFT CAPACITIES – Dipper length: 3.0m, Monoboom 5.7m, Trackshoes: 700mm, No bucket.

JS220 LC MONO

Reach	3m (9ft 10in)		4.5m (14ft 9in)		6m (19ft 8in)		7.5m (24ft 7in)		Max. Reach		Max. Reach
											
Load Point Ht.	kg	kg	kg	kg	kg	kg	kg	kg	kg	kg	mm
7.5m (24.7ft)					4350*	4350*			3440*	3440*	6285
6.0m (19.8ft)					5170*	5170*			3210*	3210*	7382
4.5m (14.9ft)					5740*	5740*	5190*	4160	3160*	3160*	8056
3.0m (9.10ft)	11580*	11580*	8380*	8380*	6630*	5600	5810*	4060	3230*	3230*	8411
1.5m (4.11ft)			10200*	8010	7560*	5370	5920	3950	3430*	3320	8488
0m	6400*	6400*	11240*	7740	8040	5210	5820	3860	3800*	3380	8293
- 1.5m (- 4.11ft)	10510*	10510*	11410*	7660	7960	5130	5790	3830	4470*	3650	7807
- 3.0m (- 9.10ft)	15320*	14880	10770*	7700	7980	5160			5790*	4260	6969
- 4.5m (- 14.9ft)	12460*	12460*	8920*	7890					6760*	5810	5619

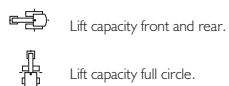

- Notes:
1. For lifting capacity including bucket, subtract total weight of bucket or bucket and quickhitch from above values.
  2. Lifting capacities are based on ISO 10567, that is: 75% of minimum tipping load or 87% of hydraulic lift capacity, whichever is the less. Lifting capacities marked\* are based on hydraulic capacity.
  3. Lift capacities assume that the machine is on firm, level ground.
  4. Lift capacities may be limited by local regulations. Please refer to your dealer.



Hydraulic Excavator JS220 SC/LC/NLC Engine Power: 128kW (172hp) Bucket Capacity: 0.40 – 1.19m<sup>3</sup> Operating Weight: 21144 – 22490kg

JCB Sales Limited, Rocester, Staffordshire, United Kingdom ST14 5JP. Tel: +44 (0)1889 590312.

Download the very latest information on this product range at: [www.jcb.com](http://www.jcb.com)

©2009 JCB Sales. All rights reserved. No part of this publication may be reproduced, stored in a retrieval system, or transmitted in any form or by any other means, electronic, mechanical, photocopying or otherwise, without prior permission from JCB Sales. JCB reserves the right to change specifications without notice. Illustrations and specifications shown may include optional equipment and accessories. The JCB logo is a registered trademark of J.C. Bamford Excavators Ltd.

